

## A QUANTUM DIGITAL UNIVERSE

### QUANTUM INFORMATION HELPS FOUNDATIONS OF PHYSICS

**GIACOMO MAURO D'ARIANO**

*Dipartimento di Fisica, Università di Pavia, Pavia, Italy*

*INFN, Gruppo IV, Sezione di Pavia, Pavia, Italy*

Quantum Information is a very interesting new discipline. It has become very popular in the last few years because it brings together a menagerie of branches of knowledge, putting in connection natural scientists – physicists, mathematicians, chemists – with computer scientists, engineers, and even philosophers, all within a single new field that spawns new technology and raises new broad fundamental problems. What makes Quantum Information unique is that, in order to bring its new technology to fruition, we are left with no choice but to probe the limits of quantum physics, pushing its boundaries both theoretically and experimentally.

#### 1 Introduction: the lesson of Quantum Information

Within the history of Quantum Information it is really fascinating to witness the evolution of the original notion of “information processing” from computer science toward a completely new and amazing concept of computation, which almost reverses the relation between mathematics and physics, in the sense that it is now physics that algorithmically “solves” a mathematical problem. This is exactly what the famous Shor’s algorithm does in factoring integers with an exponential speedup compared to known classical algorithms. Rolf Landauer was used to say that “Information is Physical”: but this is not surprising if we regard bits as necessitating a physical support to be written on. But now we are declaring the converse, namely: “Physics is Informational” – a weird and much more intriguing assertion. The physical process becomes itself a computation. A computation that does not use bits: it uses qubits (quantum bits). We have a completely new notion of information: an information that remains secret during the entire processing, and becomes openly known – *i.e.* “classical” – only at the very output, where it is read by a measurement process. A kind of information that cannot be eavesdropped even in principle, since it cannot be “cloned” [1, 2]<sup>1</sup>. The computational process is thus identified with the “Schrödinger cat” quantum quintessence: the information processing represents the coherent quantum evolution with the cat in superposition of “dead” and “alive” states (the bit value is both “0” and “1”), whereas the readout at the output represents the von Neumann collapse, with the cat being either dead or alive (the bit is either “0” or “1”).

<sup>1</sup> The “no-cloning theorem” [1] signed the beginning of the Quantum Information era. The theorem is also equivalent to the impossibility of measuring the state of a single quantum system [2].

## BOX 1

### “Where the rules come from?”



*“Nobody understands quantum mechanics!”*

Quantum Mechanics is normally presented with axioms about abstract mathematical entities, like Hilbert spaces, unit vectors, and self-adjoint operators. The theory provides rules to compute the probabilities of different outcomes in an experiment, very successful rules that are confirmed by an enormous amount of experimental data. However, the physical content of these rules has been always mysterious. Richard Feynman once remarked “I think I can safely say that nobody understands quantum mechanics” [5]. And John Wheeler said [6]: “Balancing the glory of quantum achievements, we have the shame of not knowing ‘how come’. Why does the quantum exist?”. The need for a more fundamental understanding was clear since the early days of Quantum Theory [7]. The birth of Quantum Information Science has given new ideas to attack the problem.

For what said above it is no wonder that in the last ten years Quantum Information has spawned such an unprecedented revival of interest in foundations of Quantum Theory. The new Quantum Information Science has given new ideas on how to attack quantum foundations, showing how quantum mechanics can offer the possibility for new surprising information-processing protocols. The excitement for these new discoveries has led many researchers to believe that information is the key to the solution of the mystery of quantum mechanics [3, 4] (see [box 1](#)). These ideas followed Wheeler’s program “It from bit”, which summarized the idea that “information” is the primitive notion underlying physics (see [box 2](#)).

## 2 Quantum Theory is a theory of information

Quantum Theory is a theory of information, a special kind of information that in principle is never erased. Recently Quantum Theory has been derived from six principles of purely informational nature [8–10]<sup>2</sup>. Five of these principles – i) causality, ii) local distinguishability, iii) perfect distinguishability, iv) atomicity of composition, v) ideal compressibility – are natural axioms, true for both classical and Quantum Information, and define a large class of information theories. A sixth principle – vi) purification – is the Postulate that singles out Quantum Theory, as the parallel postulate singles out Euclidean geometry among different geometries.

The general information-theoretical framework hinges around the notion of “event”, which can occur probabilistically, and has inputs and outputs “systems”. A complete collection of such events occurring with overall unit probability is called “test”. Physically a test corresponds to a measurement instrument, and the systems are just the “physical systems”. Informationally, tests and events represent subroutines, and the systems are registers on which information is read and written. In Quantum Information the tests/events are probabilistic gates, whereas the systems are qubits or general quantum systems (see [fig. 1](#)). A special case of gate is the usual unitary gate. As for the usual quantum circuits, test and events are represented by boxes with input and output wires (the systems): the output wires of a box are connected to input wires of other boxes, without making circuit loops. One writes down circuit equations as the following one (from ref. [8]):

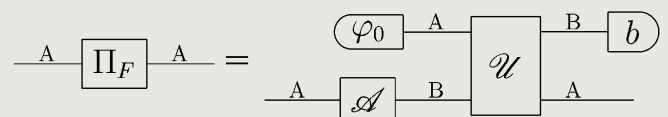

## BOX 2

### “It from Bit”



John Archibald Wheeler (mentor of Richard Feynman and inventor of the word “black hole”) speculated that the universe’s ultimate building block and most intimate mechanism might be information. “It from Bit” was the aphorism that he coined to describe this idea.

<sup>2</sup> The work [8] is the subject of the viewpoint [9], and is the conclusion of a decennial research line (see the previous work [10])

Boxes with a rounded side with no input wire represent “states” (preparation events, or else, input of the processing), whereas boxes with no output wire represent “effects” (observation events, namely final output of the processing).

The six informational principles, stated in simple informal language are the following.

**Axiom 1**

**Causality:** the probability of an event does not depend on which tests are connected to output (“information flows only from the input to the output”). This axiom is also called “no signaling from the future”, meaning that the probability of an outcome at a certain time does not depend on the choice of experiments that will be performed at later times. It also implies the “no-signaling without interaction”, (generally called simply no-signaling), which is just the Einstein causality principle.

**Axiom 2**

**Local distinguishability:** We can discriminate joint states of multiple systems by measurements on single systems. This axiom is also called local tomography, since it means that the state of a composite system can be completely determined by the joint statistics of local measurements performed over the components (see fig. 2). This axiom is the origin of the complex tensor product of quantum theory, e.g. the axiom is not satisfied by quantum theory over real Hilbert spaces.

**Axiom 3**

**Perfect distinguishability:** If a state is not compatible with some preparation, then it is perfectly distinguishable from some other state. This means that if we have some definite information about a state, we are also able to experimentally verify/falsify it with certainty.

**Axiom 4**

**Atomicity of composition:** The sequence of two atomic processes is atomic. We call “atomic” a subroutine (process) that cannot be obtained as a random choice of two inequivalent subroutines. In simple words, this principle establishes that “maximal knowledge of the episodes implies maximal knowledge of the full history”.

**Axiom 5**

**Compression:** Information can be compressed in a lossless and maximally efficient fashion. This is the axiom that introduces the notion of subsystems, e.g. the qubit is a subsystem of the “qutrit”, the bit a subsystem of the “trit”.

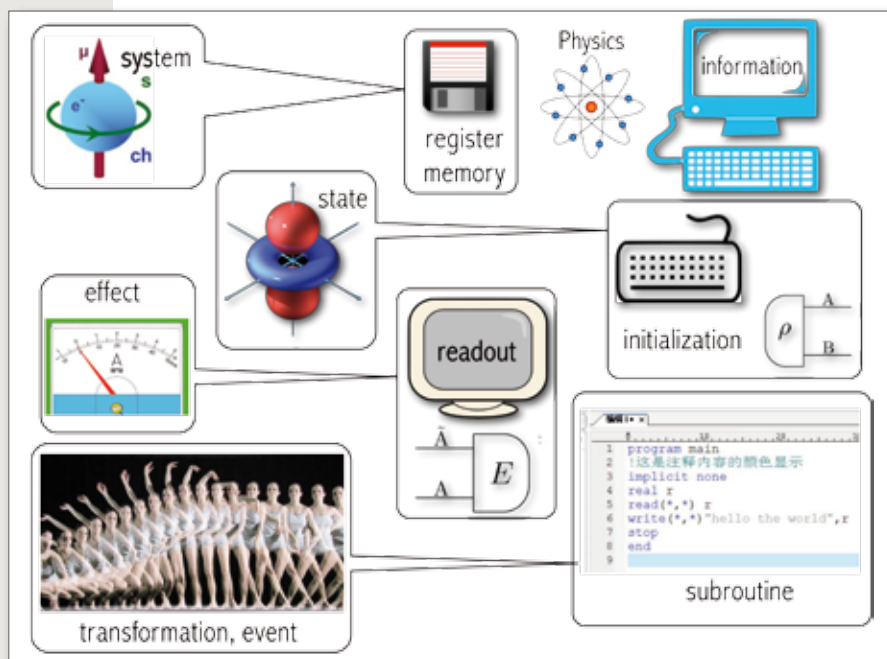

Fig. 1 Quantum Theory is a Theory of Information. Here illustrated the basic translation rules between the language of Physics and that of information processing.

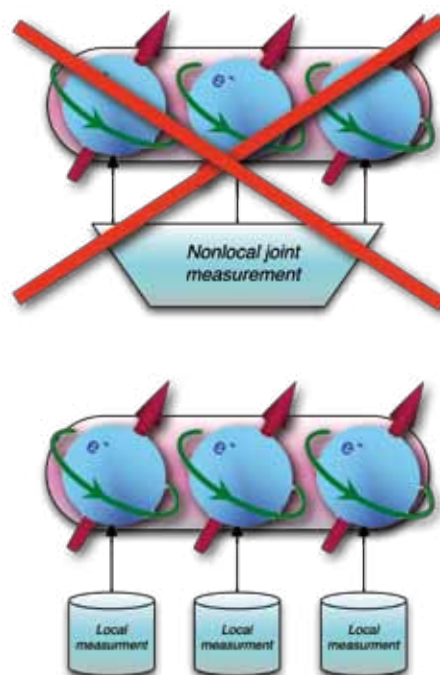

Fig. 2 Illustration of Axiom 2.



## The Purification Postulate

**Purity and Reversibility of Physical Processes:** Every process can be simulated (in an essentially unique way) as a reversible interaction of the system with a pure environment. In simple words the postulate states that every transformation can be simulated by a reversible one, by adding auxiliary input systems in a pure state. Shortly: irreversibility and mixing can be always regarded as due to discarding an “environment”, otherwise everything can be described in terms of pure states and reversible transformations. Another informal way of stating the principle is that ignorance about a part is always compatible with the maximal knowledge about the whole.

The six new principles represent a core of epistemological laws that are at the basis of science itself. For example, the causality axiom guarantees in principle the local control of the experiment. Indeed, how can we rely on any experiment if it could be scrambled from a distance or even from the future? The local discriminability axiom reconciles the “holistic nature” of the physical world with the “reductionist” scientific approach. The perfect discriminability axiom reconciles probabilism with logic, re-establishing the falsifiability of the theory. A similar role is played by the axiom on atomocity of composition.

One of the most innovative aspects of the new informational framework for Quantum Theory is the possibility of a new graphical reasoning, without the detour to the theoretical machinery, something similar to Feynman diagrams: this new kind of reasoning is a cornerstone of contemporary computer science, as pioneered by Abramsky and Coecke in Oxford [11].

### 3 Informational principles for Quantum Field Theory

The six principles for Quantum Theory have nothing of “mechanical” nature: the “Quantum Theory” derived in ref. [8] is just the abstract *theory of systems* – the mathematical framework of Hilbert spaces, algebra of observables, unitary transformations – and has no bearing on the “mechanics” – *i.e.* particles, dynamics, quantization rules – for which the name “Quantum Mechanics” would be more appropriate. Quantum Mechanics, however, is just the restriction to a fixed number of particles of the more general Quantum Field Theory, which itself is a theory of systems. The only “mechanical” elements remaining in Quantum Field Theory are the so-called “quantization rules” and the path-integral – rules that one may want to avoid in order to have a theory autonomous from the classical one, whereas it should be classical mechanics to be derived as an approximation of Quantum Field Theory via a “classicalization” rule.

But, how can we formulate a field theory that is quantum *ab initio*? We need to add some new informational principles to

the six ones of quantum theory. These are: *the Deutsch-Church-Turing principle*, and *the principle of topological homogeneity*.

**The Deutsch-Church-Turing principle:** Every physical process describable in finite terms must be perfectly simulated by a quantum computer made with a finite number of qubits and a finite number of gates<sup>3</sup>.

The principle implies that the density of information is finite (here the information is quantum, and this means that the dimension of the Hilbert space is finite). Richard Feynman himself did like the idea of finite information density, because “*he felt that there might be something wrong with the old concept of continuous functions. How could there possibly be an infinite amount of information in any finite volume?*” [13]. A relevant implication of the Deutsch-Church-Turing principle is *locality of interactions*, namely that the number of quantum systems connected to each gate is finite.

**Homogeneity of Interactions:** The interactions describing a physical law are homogeneous.

The principle means that the quantum network representing the quantum field is periodic. In the informational paradigm the physical law is represented by a set of connected quantum gates (fig. 3). The physical law experimentally is described by a finite protocol, which theoretically corresponds to a finite quantum algorithm. Thus locality is required in order to define a physical law that is under the local control of the experimenter, whereas homogeneity represents the universality of the law, which is assumed to hold everywhere and ever.

The two new informational principles together with the six ones of Quantum Theory correspond to regarding the quantum field as a quantum cellular automaton. Notice that the Deutsch-Church-Turing principle suggests considering the automata theory not as an approximation, but as an extension of Quantum Field Theory to a very small scale dominated by discreteness, as the Planck scale. The discrete theory is an extension of the continuous one since it is allowed to include localized states and observables, which are not describable in Quantum Field Theory. Localized states are generated with finite superpositions of single-system states over a vacuum that remains locally invariant under the computation.

In the discrete theory there will be no divergencies, neither ultraviolet nor infrared, whereas the path integral becomes

<sup>3</sup> In his celebrated paper on universal quantum computers [12] David Deutsch states the principle as follows: “Every finitely realizable physical system can be perfectly simulated by a universal model computer machine operating by finite means.”

a simple finite sum. On the other hand, the old Quantum Field Theory is recovered from the automata theory in the field limit, corresponding to the “thermodynamic” limit for infinitely many quantum systems and infinitely many time steps for the evolution of smooth states, namely superposition of single-system states (over a vacuum background) with coefficients that are varying slowly over the network. In such “digital world” there is no physical unit: time and space are measured by counting events and systems. The digital-analog conversion factors will be given by a time  $\tau$  expressed in seconds, and length  $a$  expressed in meters, to be interpreted as the space and time periods of the automaton – the Planck length and time, respectively. (The Planck length is an astonishingly small quantity, equivalent to 0.1 m as compared to an electron as huge as an entire galaxy!)

#### 4 “Digital” Relativity

What happens to the Relativity principle in the quantum automaton? The Minkowski space-time “emerges” from the pure topology of the quantum computation (see fig. 4), and Lorentz covariance and all continuum symmetries are recovered in the field limit. At the opposite extreme of the Planck scale all continuum symmetries are violated, and there will also be violations of the dispersion relations.

#### 5 The Dirac equation as the free flow of Information

In the digital world Lorentz covariance must emerge from the computation itself. A simple heuristic arguments shows that the equation describing the free flow of information is just the Dirac equation [16]. For simplicity we restrict to one space dimension (the argument can be extended to larger dimensions [17]). In the quantum computer information can flow in a fixed direction only at the maximum speed of one-gate-per-step, since a larger speed would violate causality, whereas a slower speed would need a zig-zag motion (see fig. 5).

In analog units, the maximal speed (which digitally is equal to 1) is given by  $c = a/\tau$ . Mathematically we describe the information flow in the two directions by the two field operators  $\psi^+$  and  $\psi^-$  for the right and the left propagation,

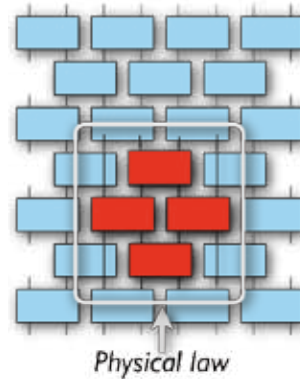

Fig. 3 In the informational paradigm the physical law is represented by a set of connected quantum gates.

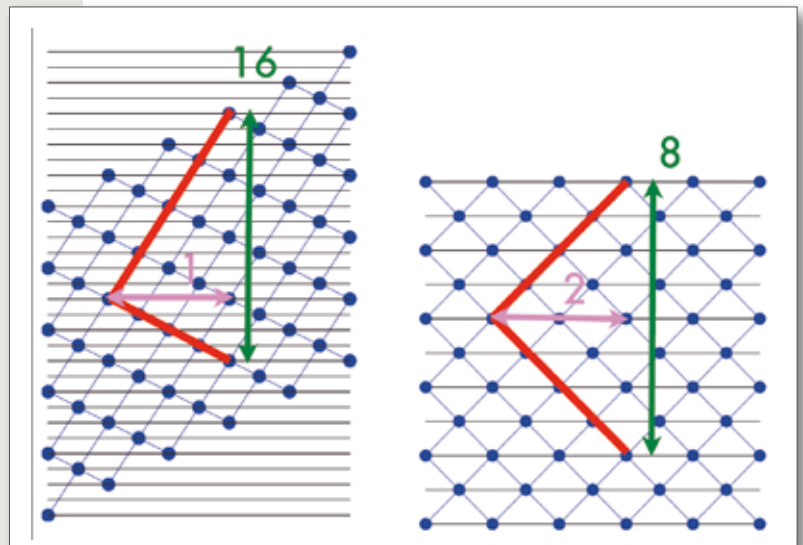

Fig. 4 A digital version of Lorentz time-dilation and space-contraction: illustration of the mechanism for the digital Lorentz time-dilation and space-contraction (from ref. [14]). In the informational framework time must be defined in terms of a global computer clock for synchronizing a parallel distributed computation [15]. Giving a rule for establishing which subroutines are called at the same time according to the global clock corresponds to build up a *foliation* on the circuit, each leaf representing space at a different time. Uniform foliations corresponds to “boosts”, namely inertial frames. The digital analog of the Lorentz space-contraction and time-dilation thus emerge in terms of an increased density of leaves and a decreased density of events per leaf in the boosted frame.

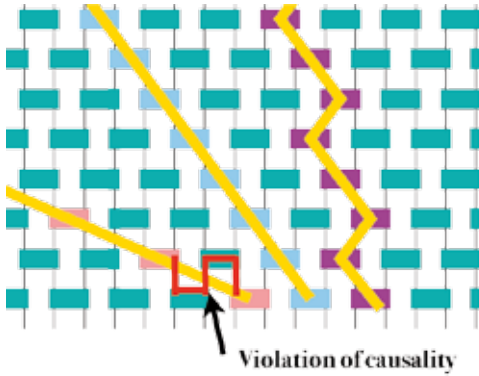

Fig. 5 Information flow in a quantum automaton (see text).

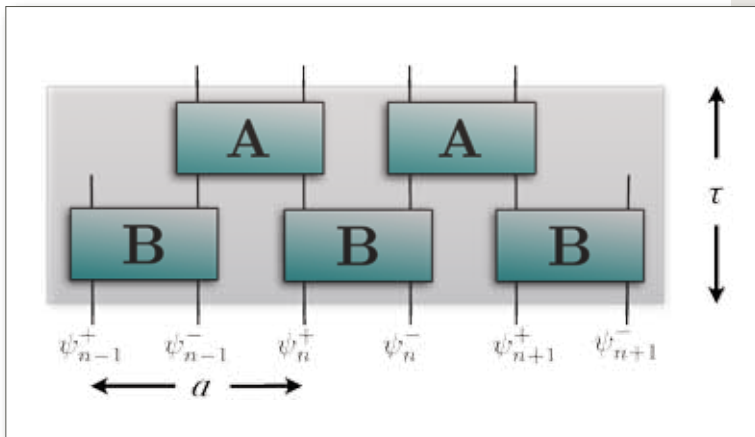

Fig. 6 The Dirac automaton.

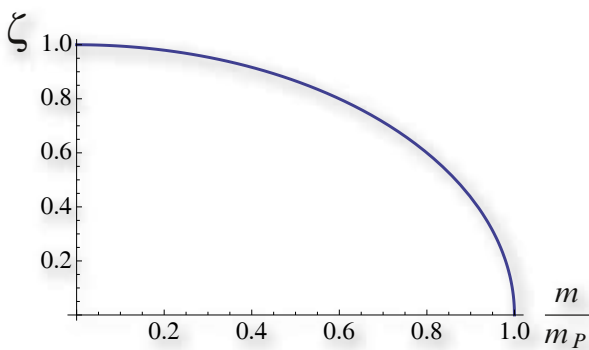

Fig. 7 Refraction index of vacuum that is a function of the mass (from ref. [16]).

respectively. In equations:

$$\hat{\partial}_t \begin{bmatrix} \psi^+ \\ \psi^- \end{bmatrix} = \begin{bmatrix} -c\hat{\partial}_x & 0 \\ 0 & c\hat{\partial}_x \end{bmatrix} \begin{bmatrix} \psi^+ \\ \psi^- \end{bmatrix},$$

where the hat on the partial derivative denotes that they are discrete finite differences. If we take the maximal information speed  $c$  as a universal constant, then  $c$  must be the speed of light. Now, the only way of slowing-down the information flow is to have it changing direction repeatedly. The homogeneity postulate requires the zig-zag to be periodic (corresponding to a constant average speed), and this is described mathematically by a coupling between  $\psi^+$  and  $\psi^-$  with an imaginary constant. Upon denoting by  $\omega$  the angular frequency of such periodic change of direction, we have

$$\hat{\partial}_t \begin{bmatrix} \psi^+ \\ \psi^- \end{bmatrix} = \begin{bmatrix} -c\hat{\partial}_x & -i\omega \\ -i\omega & c\hat{\partial}_x \end{bmatrix} \begin{bmatrix} \psi^+ \\ \psi^- \end{bmatrix},$$

which is just the Dirac equation without spin (the derivation of the spin is meaningful only for larger space dimension).

The slowing-down of information propagation due to the zig-zag can be regarded as the informational meaning of inertial mass, quantified by the angular frequency  $\omega$ . The analogy with the Dirac equation leads us to write the coupling constant in terms of the Compton wavelength  $\lambda = c\omega^{-1} = \hbar/(mc)$  (corresponding to the identity  $m = \hbar c^{-2}\omega$  between the Planck quantum and the rest energy): this can be regarded as a reinterpretation of the Planck constant in terms of the conversion factor between the informational notion of inertial mass in  $s^{-1}$  and its customary notion in kg.

## 6 The Dirac automaton

The Dirac automaton [16] is described by the periodic quantum circuit in fig. 6 where gate  $B$  is simply a swap, whereas gate  $A$  is an  $SU(2)$  unitary transformation corresponding to a rotation of  $2\theta$ . The corresponding field evolution is given by

$$\begin{bmatrix} \psi_n^+ \\ \psi_n^- \end{bmatrix} (t + \tau) = \mathbf{U} \begin{bmatrix} \psi_n^+ \\ \psi_n^- \end{bmatrix} (t)$$

with

$$\mathbf{U} = \begin{pmatrix} \sin \theta \hat{\partial}_- & -i \cos \theta \\ -i \cos \theta & \sin \theta \hat{\partial}_+ \end{pmatrix},$$

where  $\tau$  is the time duration of each step and the partial derivatives symbols denote the discrete shifts on the left

(right) corresponding to the + (–) sign, respectively. The form of coefficients  $\sin\theta$  and  $\cos\theta$  is due to the unitarity of the evolution. The comparison with the finite-difference Dirac equation identifies the coefficients as follows:

$$\cos\theta = \frac{a}{\lambda} = \frac{m}{m_P}, \quad \sin\theta = \zeta = \sqrt{1 - \left(\frac{m}{m_P}\right)^2}, \quad m_P = \frac{\hbar}{ac},$$

where  $m_P$  is the Planck mass, and  $\zeta$  rescales the speed of light as an inverse refraction index. Thus we see how unitarity implies a renormalization of the speed of light in the Dirac equation, corresponding to a refraction index of vacuum that is a function of the mass  $m$ , and which is monotonically decreasing and vanishes at the Planck mass  $m = m_P$  (see [fig. 7](#)). This phenomenon belongs to the class of *violation of dispersion relations* that are expected in a discrete space-time. It is a very general phenomenon, due to the combined effects of unitarity and discreteness, which occurs in any space dimension and for any quantum cellular automata. The automaton theory provides a description of the Dirac field at all scales, ranging from the Planck one up to the customary field-limit (achieved asymptotically for large number of steps and delocalized smooth states). The theory depends on a single parameter, corresponding to the mass in Planck units, and predicts that the Planck mass is the largest possible mass for a Dirac particle. The Planck constant itself can be redefined as a derived quantity, obtained as the product of the maximum mass  $m_P$ , the minimum distance  $a$ , and the speed of light  $c$ .

## 7 Emergent Hamiltonian

Differently from Quantum Field Theory, in the quantum cellular automaton there is no Hamiltonian: all interactions are local, they are made with quantum gates that produce transformations far from the identity, otherwise we would need an unbounded maximum speed of the information flow in order to get finite average speed, recovering Einstein causality only in a continuum limit. However, surprisingly, we can reversely obtain the classical field Hamiltonian from the unitary transformation, via the following identity:

$$H = -\frac{i\hbar}{2\tau} \sum_n \begin{bmatrix} \psi_n^+ \\ \psi_n^- \end{bmatrix}^\dagger (\mathbf{U} - \mathbf{U}^\dagger) \begin{bmatrix} \psi_n^+ \\ \psi_n^- \end{bmatrix}.$$

As a (normal ordered) operator such Hamiltonian provides the correct evolution of the field according to the identity

$$i\hbar\hat{\partial}_\tau\psi_n^\pm = [H, \psi_n^\pm].$$

### BOX 3

#### The Feynman problem



Feynman said: “I’m not sure whether Fermi particles could be described by such a system [quantum computer]. So I leave that open. Well, that’s an example of what I meant by a general quantum mechanical simulator. I’m not sure that it’s sufficient, because I’m not sure that it takes care of Fermi particles” [18].

The problem precisely: Write Fermi fields using Pauli matrices in such a way that any observable in the field operator (*i.e.* bilinear products of field operators) contains only Pauli operators in the same locations of the field operators.

## 8 Replacing fields with qubits only: the digital neutrino?

In a quantum-digital world there are only qubits that are unitarily interacting: the discretely labelled quantum field of the automaton must be eliminated from the framework, and rewritten in terms of qubits only. The field is a nonlocal operator (anticommutation is nonlocal), and is realized as a product of Pauli matrices everywhere on the lattice. This poses the nontrivial problem if it is possible to rewrite the local field unitary interactions in a way that involves local qubits only. Such a problem has been posed by Feynman himself (see [box 3](#)).

The Fermi field can be easily eliminated in our one-dimensional Dirac automaton using the Jordan Wigner construction [19], resulting in simple two-qubit gates as in ref. [16]. It is easy to see that the vacuum state that is annihilated by the field operator is left locally invariant by the automaton, and is simply made with all qubits in the down state  $\downarrow$ . On the other hand, the field creates a qubit in the state  $\uparrow$  in its same location. The problem is much more difficult for larger space dimensions, where it can be solved by adding a Majorana auxiliary field written in terms of additional qubits [20, 21]. The ancillary qubits are prepared in a special state that remains invariant under the evolution, and just takes care of the anti-symmetrization of fermions. It is not clear yet if such construction for the field is essentially unique,



in which case it may provide an informational motivation for a neutrino to be associated to a lepton.

## 9 Digital particles and antiparticles

Using the mentioned Jordan Wigner in one dimension we can construct single-particle states by superimposing single  $\uparrow$  qubits in a vacuum made of all qubits in the state  $\downarrow$ . Particle (antiparticle) states correspond to have equal (opposite) amplitudes for left and right qubits at the same location  $n$  on the lattice, whereas the momentum is given by putting a constant phase shift between neighboring locations, as, for example, in the following state:

$$|\Psi\rangle = \sum_n g_n e^{in\phi} (|\psi_n^+\rangle \pm |\psi_n^-\rangle),$$

where  $|\psi_n^\pm\rangle$  denotes the  $\uparrow$  qubit state in left/right field (see fig. 6). The *smooth states* of the field-limit correspond to choosing the coefficients  $g_n$  as slowly varying *versus*  $n$ , *i.e.* highly delocalized. The evolution of a smooth state with Gaussian envelope  $g_n$  is reported in fig. 8 and fig. 9 for a single particle and in fig. 10 for two particles (the square modulus of the coefficients in the qubit basis is plotted).

## 10 The quantum-digital fabric of space-time

For space dimension greater than 1 a classical digital space-time would suffer the Weyl tiling problem [22], which states the impossibility of emergence of an isotropic metrical space from a discrete geometry. Weyl said that in a two-dimensional square tiling one would count the same number of squares along the directions of the side and along the diagonal, and this problem is clearly not cured by the continuum limit. Recently it has been proved that the maximal speed of information flow attainable in a periodic causal network is necessarily non-isotropic, since the set of points attainable in a given maximum number of steps is a polytope that does not approach a circle [23]. Thus the maximal speed of information flow cannot be isotropic in a classical causal network. This problem could be cured by considering a random causal network, as in the case of the Sorkin framework for quantum gravity [24]: however, in the present logic, such randomness would violate the topological homogeneity principle, and would correspond to a "random physical law". It is instead the same quantum nature of the space-time fabric emerging from the quantum cellular automaton that cures the anisotropy, with superposition of paths restoring the isotropy of the maximal speed of propagation of information [25]. This is proved by the the continuum limit of the Bialynicki-Birula automaton [26] approaching the Dirac equation in the continuum limit of  $a \rightarrow 0$  (via Trotter's formula), since the anisotropy would

otherwise persist in the continuum limit. The same isotropy is restored in the field-limit of smooth states. This shows that the quantum nature of the causal network plays a crucial role in having Minkowski space-time as emergent from the discrete geometry of the quantum cellular automaton.

## 11 Can we experimentally see the digital nature of space-time?

The digital framework at the Planck scale is in principle detectable through violations or "deformations" of symmetries – *e.g.* with the Planck length/energy invariant along with the speed of light, as in the doubly special relativity of Amelino-Camelia [27] or in the deformed Lorentz transformations of Magueijo and Smolin [28]. Another possibility is detecting violations of dispersion relations, as for the mass-dependent refraction index of the vacuum for the Dirac automaton shown in fig. 7. In this case the leading correction of the constant  $c$  is of the order of  $(m/m_p)^2$  which for a proton is about  $1.5 \times 10^{-37}$  – a very small number indeed. In the last years amazingly a number of experimental methods have been proven to be effective in testing the Planck scale. For example ultra-energetic gamma ray bursts from distant cosmological objects can signal Lorentz invariance violation by measuring the helicity dependence of the propagation velocity of photons (vacuum birefringence) [29]. It has also been suggested that Planck-scale deformation of Lorentz symmetry can be the solution to the ultrahigh energy cosmic ray (above the Greisen-Zatsepin-Kuzmin threshold) and the TeV-photon conundrums [30]. Ultra-precise cold-atom-recoil experiments can be used to constrain the form of the energy-momentum dispersion relation in the low speed limit of the dispersion relation, complementary to analogous investigations of the dispersion relation using cosmic rays [31]. In this case the exceptional sensitivity of cold-atom-recoil experiments remarkably allows us to set a limit within a single order of magnitude of the desired Planck-scale level for the leading correction in the non-relativistic limit. This provides the first example of Planck-scale sensitivity in the study of the dispersion relation in controlled laboratory experiments. The next-to-leading term is only a few orders of magnitude away from the Planck scale, but still amounts to the best limit on a class of Lorentz-symmetry test theories that has been extensively used to investigate the hypothesis of "deformation" (rather than breakdown) of space-time symmetries. Remarkably, Craig J. Hogan at Fermilab has built a holometer (Michelson interferometer) which should be able to test a random Planckian walk in form of a special type of noise [32]. Finally, a strong evidence of Lorentz-covariance violation would be represented by an experimental violation of CPT.



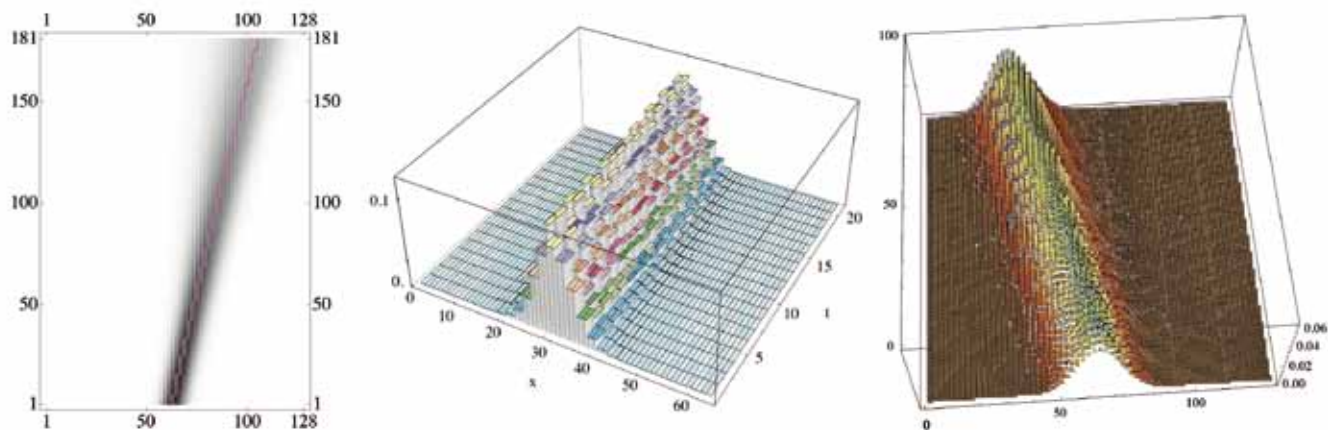

Fig. 8 The evolution of a single-particle Gaussian packet (probability distribution of qubit  $\uparrow$ ) with  $\Delta = 2, \theta = \pi/4$ , for 180 time steps, using 128 qubits (half of them for left and half of them for right particles). The red line is the typical path, corresponding to the classical trajectory. The parameter  $\cos \theta$  with  $\theta = \pi/8$  here corresponds to  $m \approx 0.92 m_p$ . On the center the 3D details are given (both figures from ref. [20]). On the right another particle state in a 3D plot.

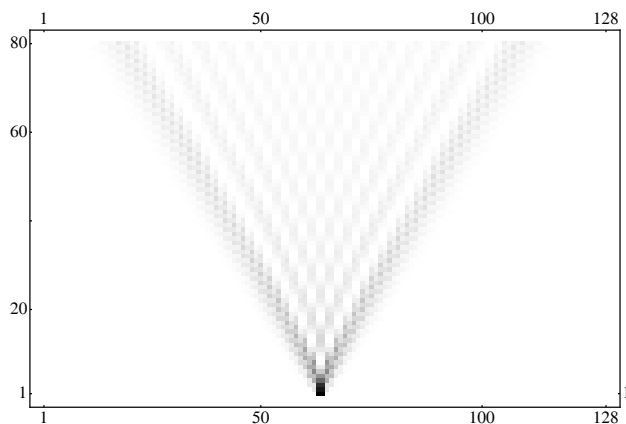

Fig. 9 The evolution of a localized state for  $\theta = \pi/10$ . Such kind of states cannot be described by the customary field theory, and have no simple field limit. Notice how fast the localized states broadens, compared to smooth ones.

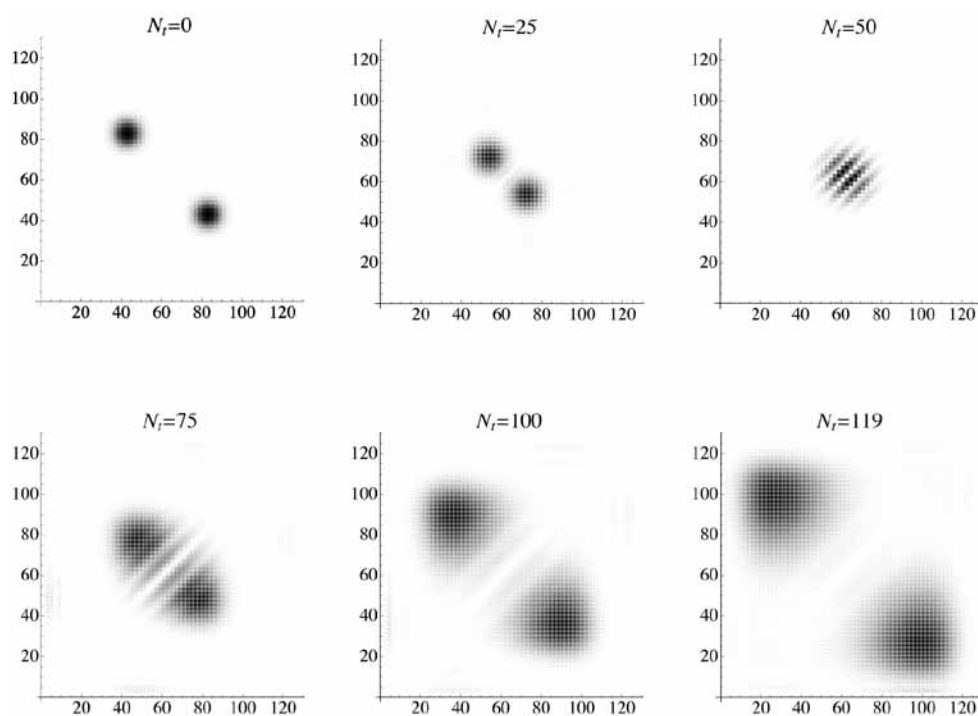

Fig. 10 Evolution at different time-steps  $N_t \tau$  of a two-particle state made upon antisymmetrizing the two Gaussian packets in collision with  $x_0 = \pm 10, \Delta = 2, k = \pm \pi/4$ , 128 qubits. Here  $m \approx 0.92 m_p$  as in the previous figure. The plot represents the square modulus of the antisymmetric matrix of state coefficients, with the vertical and the horizontal axes denoting the matrix indexes, namely the one-dimensional coordinates of the two particles. The symmetry along the diagonal is the result of indistinguishability. Notice the empty diagonal, corresponding to the Pauli exclusion principle (from ref. [20]).

## 12 What about Gravity?

The big question is now where gravity comes from. At this early stage of this quantum-digitalization program we can only hypothesize possible lines of research. A very appealing possibility is to believe in a strong version of the equivalence principle, *i.e.* that inertial and gravitational masses are actually the same “informational” entity. This means that gravity must be a quantum effect. This idea, crazy as it seems, is actually not new, and has been considered by Andrei Sakharov with his induced gravity almost fifty years ago [33]. The work of Seth Lloyd [34] is also in the same spirit. Literally the idea that gravity is a quantum effect means that it should be exhibited at the level of the free Dirac field, whence such an effect should be truly a manifestation of the digital nature of the field, a low-order digital correction to the analog free-field theory. This way of looking at gravity is deeply connected to the idea of Ted Jacobson and Erik Verlinde, where gravity is an entropic force [35]. In this approach the only unproved ingredient is a generalized version of the holographic principle, which is of perfectly digital nature. The goal is therefore to derive the principle from the quantum automaton evolution. There are, however, problems yet to be solved, for example the existence of infinitely many automata having the same field-limit, suggesting the existence of some new principle that selects the correct automaton. As we have seen, the information flow halts at the Planck mass, and this seems mysteriously related to the holographic principle.

The “informational era” of physics is only at the beginning: we have a long way in front of us.

### References

- [1] W. K. Wootters and W. H. Zurek, *Nature*, 299 (1982) 802; D. Diecks, *Phys. Lett. A*, 92 (1982) 271.
- [2] G. M. D'Ariano and H. P. Yuen, *Rev. Lett.*, 76 (1996) 2832.
- [3] Gilles Brassard, *Nature Physics*, 1 (2005) 2.
- [4] C. Fuchs, *J. Mod. Opt.*, 50 (2003) 987.
- [5] R. Feynman, *The Character of Physical Law* (Modern Library) 1994.
- [6] J. A. Wheeler, *New York Times*, December 12, 2000.
- [7] G. Birkhoff and J. von Neumann, *Ann. Math.*, 37 (1936) 743.
- [8] G. Chiribella, G. M. D'Ariano, and P. Perinotti, *Phys. Rev. A*, 84 (2011) 012311.
- [9] C. Brukner, *Physics*, 4 (2011) 55.
- [10] G. M. D'Ariano, in *Philosophy of Quantum Information and Entanglement*, Edited by A. Bokulich and G. Jaeger (Cambridge University Press, Cambridge, UK) 2010.
- [11] S. Abramsky and B. Coecke, *Proceedings of the 19th IEEE conference on Logic in Computer Science* (2004) pp. 415-425.
- [12] D. Deutsch, *Proc. R. Soc. London A*, 400 (1985) 97.
- [13] Quoted from: M. Misky, in *Feynman and Computation*, edited by J. G. Hey (Westview, Boulder, Oxford) 2002.
- [14] G. M. D'Ariano, in *AIP Conf. Proc.*, Vol.1232 *Quantum Theory: Reconsideration of Foundations*, 5, edited by A. Y. Khrennikov (AIP, Melville, New York, 2010), p. 3 (also arXiv:1001.1088).
- [15] L. Lamport, *Communications of the ACM*, 21 (1978) 558.
- [16] G. M. D'Ariano, *Phys. Lett. A*, 376 (2012) 697 [arXiv:1012.0756].
- [17] G. M. D'Ariano and A. Tosini, unpublished.
- [18] R. P. Feynman, *Int. J. Th. Phys.*, 21 (1982) 467.
- [19] P. Jordan and E. Wigner, *Z. Phys.*, 47 (1928) 631.
- [20] G. M. D'Ariano, arXiv: 1110.6725 (2011).
- [21] G. M. D'Ariano and A. Tosini, in preparation.
- [22] H. Weyl, *Philosophy of Mathematics and Natural Sciences* (Princeton University Press, Princeton) 1949.
- [23] T. Fritz, *Velocity Polytopes of Periodic Graphs*, arXiv:1109.1963 (2011).
- [24] L. Bombelli, J. Lee, D. Meyer, and R. D. Sorkin, *Phys. Rev. Lett.*, 59 (1987) 521.
- [25] G. M. D'Ariano, *Adv. Sci. Lett.*, 5 (2012) in press, reprinted from: A Quantum-digital Universe, FQXi Essay Contest Is Reality Digital or Analog? (2011) [<http://fqxi.org/community/essay/winners/2011.1>].
- [26] I. Białynicki-Birula, *Phys. Rev. D*, 49 (1994) 6920.
- [27] G. Amelino-Camelia, *Nature*, 418 (2002) 34.
- [28] J. Magueijo, L. Smolin, *Phys. Rev. Lett.*, 88 (2002) 190403.
- [29] P. Laurent, D. Götz, P. Binétruy, S. Covino, and A. Fernandez-Soto, *Phys. Rev. D*, 83 (2011) 121301.
- [30] G. Amelino-Camelia, and T. Piran, *Phys. Rev. D*, 64 (2001) 036005.
- [31] F. Mercati, D. Mazon, G. Amelino-Camelia, J. M. Carmona, J. L. Cortes, J. Induráin, C. Lämmerzahl, and G. M. Tino, arXiv gr-qc/1004.0847 (2010). G. Amelino-Camelia, C. Lämmerzahl, F. Mercati, and G. M. Tino, arXiv gr-qc/0911.1020 (2009).
- [32] C. Hogan, *Phys. Rev. D*, 85 (2012) 064007; M. Moyer, *Sci. Am.*, February (2012) 21.
- [33] A. D. Sakharov, *Sov. Phys. Dokl.*, 12, 1040 (1968) [Dokl. Akad. Nauk Ser. Fiz. 177 70 (1968)]. Reprinted in *Gen. Rel. Grav.* 32 (2000) 365.
- [34] S. Lloyd, quant-ph:0501135 (2005).
- [35] T. Jacobson, *Phys. Rev. Lett.*, 75, (1995) 1260; E. Verlinde, arXiv: 1001.0785 (2010).

### Giacomo Mauro D'Ariano

Is Full Professor at the University of Pavia, where he teaches Physical Theory of Information and Foundations of Quantum Mechanics. Founder and leader of the Quantum Information Theory Group (QUIT), he is also member of the Center for Photonic Communication and Computing of Northwestern University in Evanston, Illinois. With his group he conceived and developed the quantum tomography method for states and transformations, introduced the method of quantum combs for quantum protocols, designed numerous optimal quantum protocols and measurements, and recently derived the mathematical structure of Quantum Theory from information-theoretic principles.